









Pneumatic rotary actuator

- Modular program for mounting of quarter turn valves such as ball valves and butterfly valves
- NAMUR and ISO 5211 interfaces
- Position feedback with Type 1061 possible (also for Ex-applications)
- SideControl Positioner ready - Type 8792/3
- ATEX 2014/34/EU



Product variants described in the data sheet may differ from the product presentation and description.

Can be combined with

	Type 2654 2/2-way ball valve 3-piece	▶
	Type 2651 2/2 or 3/2 way Ball Valve, 2-Piece	▶
	Type 2671 Butterfly valve	▶
	Type 2657 Ball Valve, manual- ly-operated	▶
	Type 2674 Plastic butterfly valve	▶
	Type 8792 Digital electropneumatic Positioner SideControl	▶
	Type 1061 Accessory for pneumatic rotary actuators	▶

Type description

The Type 2051 pneumatic rotary actuators are low maintenance single or double acting pneumatic linear piston actuators where linear movement of the piston due to the pilot air causes a 90° rotation of the connected valve. Actuator-valve coupling is made via a universal ISO 5211 mechanical interface. The status of ball or butterfly valve can be monitored via the feedback switches of Type 1061. Moreover the actuator can be used as modulating control actuator by the addition of Bürkert's range of Side Control positioners 8792/3.

Table of contents

1. General technical data	3
2. Circuit functions	3
3. Materials	3
3.1. Chemical Resistance Chart – Bürkert resistApp.....	3
4. Dimensions	4
5. Product operation	5
5.1. Functional overview	5
6. Ordering information	6
6.1. Bürkert eShop – Easy ordering and quick delivery.....	6
6.2. Bürkert product filter.....	6
6.3. Ordering chart.....	7
Double-acting actuator	7
Single-acting actuator.....	8
6.4. Ordering chart accessories.....	8
Position feedback 1061	8
Positioner 8792	9
Positioner mounting kit 8792/3.....	9
Solenoid valve 6519.....	9
Cable plug Type 2516	9
Conversion Sleeve	9

1. General technical data

Product properties	
Dimensions	Detailed information can be found in chapter "4. Dimensions" on page 4.
Material	
Actuator	Aluminium alloy
Piston	Aluminium
Seal	Special NBR
Performance data	
Rotation	90°, adjustable to -5°...95°
Adjustable angle	20° per end position
Control pressure	3...8 bar, single-acting 2.5...8 bar, double-acting Max. 8 bar
Media data	
Control medium	Filtered compressed air with or without oil
Process/Port connection & communication	
Interface	
Pilot air port	NAMUR Flange interface VDE/VDI 3845
Feedback signal	NAMUR VDE/VDI 3845
Fittings	ISO 5211
Approvals and certificates	
Approvals	ATEX: 2014/34/EU IEC: 61508 SIL 2
Environment and installation	
T _{umg}	-40 °C...+80 °C (FKM: -15 °C...+150 °C)

2. Circuit functions

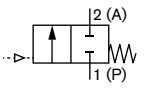
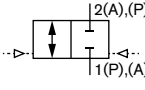
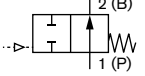
Control function	Description
	Type: A, pneumatically operated on/off valve 2/2 way Flow direction above seat Normally closed by spring force
	Type: I, pneumatically operated on/off valve on either side 2/2 way Bidirectional Normally closed (without spring)
	Type: B, single-acting actuator for pneumatically operated on/off valve 2/2 way Normally opened by spring force

3. Materials

3.1. Chemical Resistance Chart – Bürkert resistApp



Bürkert resistApp – Chemical Resistance Chart

You want to ensure the reliability and durability of the materials in your individual application case? Verify your combination of media and materials on our website or in our resistApp.

[Start Chemical Resistance Check](#)

4. Dimensions

Note:
Dimensions in mm

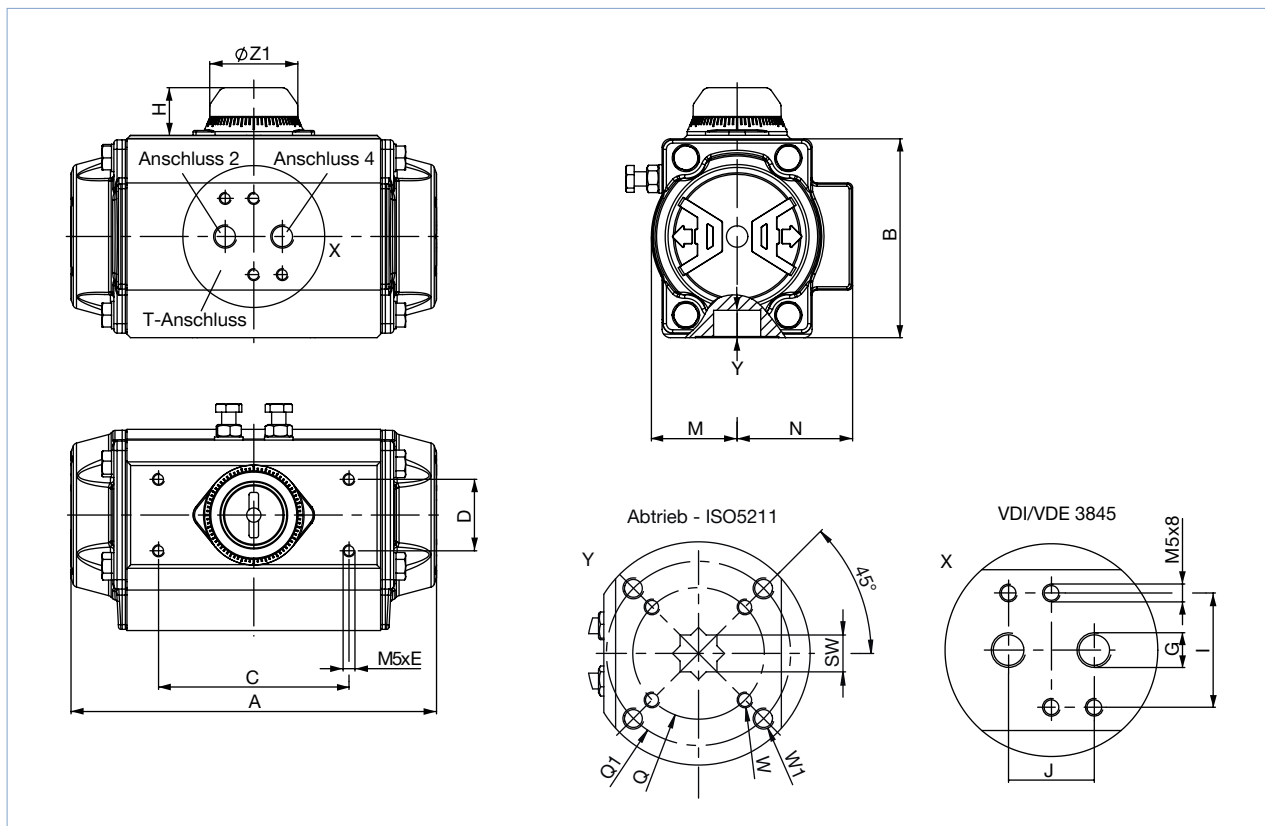

Size	A	B	C	D	E	H	I	J	M	N	Q	Q1	W	W1	ØZ1	G	Y ^{1.)}	SW ^{2.)}	ISO 5211 ^{2.)}
15	136	69	80	30	8	20	32	24	29	43	36	50	M5	M6	42	1/8"	12	11	F03-05
30	153.5	85	80	30	8	20	32	24	36	48.5	50	70	M6	M8	42	1/8"	16	14	F05-07
60	203.5	102	80	30	8	20	32	24	42.5	50.5	50	70	M6	M8	42	1/8"	18	14	F05-07
100	241	115	80	30	8	20	32	24	49.5	56.5	50	70	M6	M8	42	1/8"	19	17	F05-07
150	259	127	80	30	8	20	32	24	55.5	63	70	102	M8	M10	42	1/4"	24	17	F07-10
220	304	145	80	30	8	30	32	24	64	72	70	102	M8	M10	58	1/4"	30	22	F07-10
300	333	157	80	30	8	30	32	24	69.5	77	70	102	M8	M10	58	1/4"	34	22	F07-10
450	394.5	177	80	30	8	30	32	24	80	86	102	125	M10	M12	67.5	1/4"	39	27	F10-12
600	422.5	196	80	30	8	30	32	24	88	93	102	125	M10	M12	67.5	1/4"	40	27	F10-12
900	474	220.5	130	30	8	50	32	24	99	101	102	125	M16	-	80	1/4"	39	27	F10-12
1200	528	245	130	30	8	50	32	24	110	111.5	102	125	M16	-	80	1/4"	40	27	F10-12
2000	605	298.5	130	30	8	50	45	40	131	131	140	-	M20	-	115	3/8"	63	36	F14
3000	710	330	130	30	8	50	45	40	165	165	165	-	M20	-	115	1/2"	51	46	F16
4000	812	383	130	30	8	50	45	40	185.5	185.5	165	-	M20	-	115	1/2"	51	46	F16
5000	876	410	130	30	8	50	45	40	204	214	165	254	M20	M16	115	1/2"	60	55	F16-25
10000	950	518	200	50	M6x10	80	45	40	255	273	165	254	M20	M16	115	1/2"	80	75	F16-25-30

1.) The depth depends on the width across flats SW (other depths for different width across flats are possible).

2.) Other interfaces on request

DTS 1000104926 EN Version: M Status: RL (released | freigegeben | valide) printed: 19.11.2019

5. Product operation

5.1. Functional overview

Note:

- Illustration shows top view
- Detailed information about the control functions can be found in chapter “2. Circuit functions” on page 3.

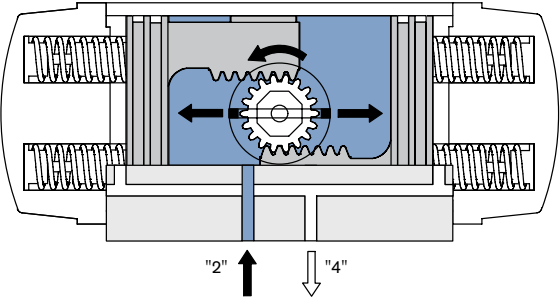
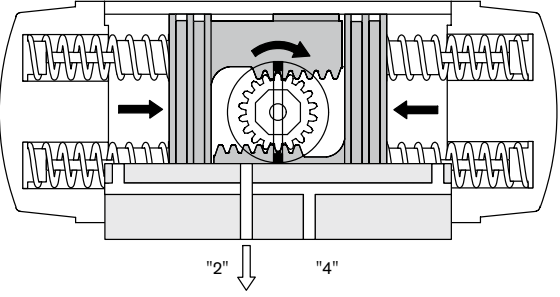
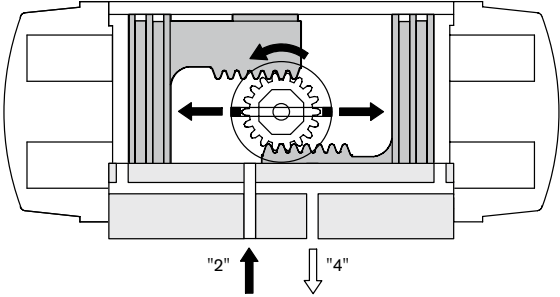
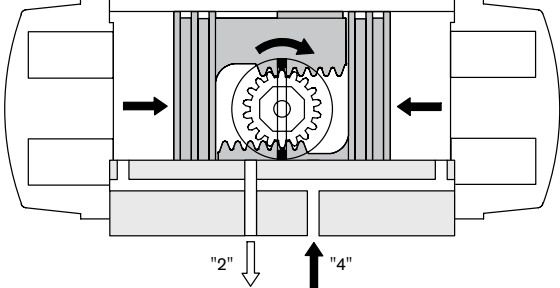
<p>Control function A</p> 	<p>Description</p> <p>Air supplied to Port „2“ forces the pistons toward the actuator end caps, compressing the springs. A counter-clockwise rotation is achieved. Exhaust air exits from Port 4.</p>
	<p>The loss of air pressure (air or electric failure) at Port „2“ allows the springs to force the pistons inward. A clockwise rotation is achieved. Exhaust air exits from Port 2.</p>
<p>Control function B</p>	<p>Description</p> <p>Control function B is the opposite rotating direction of control function A.</p>
<p>Control function I</p> 	<p>Description</p> <p>Air supplied to port 2 forces the pistons towards the actuator end caps. A counter-clockwise rotation is achieved. Exhaust air exits from Port 4.</p>
	<p>Air supplied to Port 4 forces the pistons inward. A clockwise rotation is achieved. Exhaust air exits from Port 2.</p>

DTS 1000104926 EN Version: M Status: RL (released | freigegeben | valide) printed: 19.11.2019

6. Ordering information

6.1. Bürkert eShop – Easy ordering and quick delivery



Bürkert eShop – Easy ordering and fast delivery

You want to find your desired Bürkert product or spare part quickly and order directly? Our online shop is available for you 24/7. Sign up and enjoy all the benefits.

[Order online now](#)

6.2. Bürkert product filter



Bürkert product filter – Get quickly to the right product

You want to select products comfortably based on your technical requirements? Use the Bürkert product filter and find suitable articles for your application quickly and easily.













[Try out our product filter](#)

6.3. Ordering chart

Double-acting actuator

Note:

- Control function I (see: “2. Circuit functions” on page 3)
- Other versions on request

Actuator size	Torque (depending on the control pressure)							Air volume		Rotation time ^{1.)}		Weight	Article no.
	3 bar	4 bar	5 bar	5.5 bar	6 bar	7 bar	8 bar	Opening	Closing	Open	Closed		
	[Nm]	[Nm]	[Nm]	[Nm]	[Nm]	[Nm]	[Nm]	[l]	[l]	[s]	[s]		
15	10	13.3	16.6	18.3	19.9	23.3	26.6	0.09	0.15	0.2	0.25	1	214520 
30	17.6	23.5	29.3	32	35.2	41	46.9	0.16	0.26	0.25	0.3	1.6	214522 
60	34.9	46.5	58.2	64	69.8	81.4	93.1	0.31	0.49	0.3	0.35	2.7	214524 
100	54.9	73.2	91.5	101	110	128	146	0.51	0.78	0.4	0.5	3.7	214525 
150	79.8	106	133	146	160	186	213	0.71	1.11	0.5	0.6	5.2	214526 
220	129	172	215	236	258	301	344	1.19	1.8	0.7	0.8	8	214527 
300	166	222	277	305	332	388	433	1.54	2.34	0.9	1.1	9.8	214528 
450	261	348	435	478	522	609	696	2.41	3.78	1.2	1.4	14.2	220987 
600	340	454	567	624	681	794	908	3.14	4.92	1.5	1.7	17.8	286926 
900	459	613	766	842	919	1072	1225	4.26	6.89	2.0	2.2	24.3	286928 
1200	638	851	1064	1170	1276	1489	1702	5.94	9.46	2.7	3.2	34.3	286931 
2000	1072	1430	1787	1966	2144	2502	2859	10	15.2	3.5	4.0	54.6	286934 
3000	1556	2075	2594	2853	3112	3631	4150	14.5	21.38	4.0	4.5	76.3	On request
4000	2154	2872	3590	3949	4308	5026	5744	20	33	5.0	6.0	118	On request
5000	2703	3604	4504	4955	5405	6306	7207	25	40	6.0	7.0	127	On request
10000	5003	6671	8339	9173	10007	11674	–	49	84	8.0	9.0	170	On request

1.) The operating times of the actuator were determined under the following test conditions: (1) Room temperature; (2) Angle of rotation 90°, (3) solenoid valve with Ø 11 mm and flow rate Qn 6000 l/min, (4) internal Ø 11 mm, (5) medium technical air, (6) air pressure 5.5 bar (79.75 Psi), (7) actuator without external load.

Caution: Closing times may change under different operating conditions. Control medium: The control medium must be free of dust and oil. The maximum Particle size must not exceed 30 µm (ISO 8573 Part1, Class 5). To avoid water condensation and/or ice formation (at working temperatures below 0 °C), the medium must have a dew point of -20 °C or at least 10 °C below ambient temperature (ISO 8573 Part 1, Class 3).

Single-acting actuator

Note:

- Control function A (see: “2. Circuit functions” on page 3)
- 6 spring packages per side

Actuator size	Torque (depending on the control pressure)								Spring force		Air volume		Rotation time ^{1.)}		Weight [kg]	Article no. (Control function A)	Article no. (Control function B)
	5.5 bar		6 bar		8 bar		Open- ing	Clos- ing			Open	Closed					
	0°	90°	0°	90°	0°	90°			90°	0°							
	[Nm]	[Nm]	[Nm]	[Nm]	[Nm]	[Nm]	[Nm]	[Nm]	[l]	[l]	[s]	[s]					
15	10.2	6.6	11.9	8.2	18.5	14.9	11.7	8.1	0.09	0.15	0.25	0.30	1.1	214529	214537		
30	18.9	12	21.9	14.9	33.6	26.7	20.2	13.3	0.16	0.26	0.30	0.35	1.7	214530	214538		
60	37.5	22.4	43.3	28.3	66.5	51.5	41.5	26.5	0.31	0.49	0.40	0.50	3.1	214531	214539		
100	56.7	31.4	65.8	40.5	102	77.1	69.3	44	0.51	0.78	0.50	0.60	4.3	214532	214540		
150	85.4	51.7	99	65	152	118	94.5	60.8	0.71	1.11	0.70	0.90	6.1	214533	214541		
220	138	79	159	101	245	187	157	98.4	1.19	1.8	0.90	1.10	9.3	214534	214542		
300	179	107	206	135	317	245	198	126	1.54	2.34	1.2	1.4	12	214535	214543		
450	281	169	324	213	498	386	309	198	2.41	3.78	1.5	1.8	17	214536	214545		
600	355	255	411	282	638	509	399	269	3.14	4.92	1.8	2.1	21.4	286924	286925		
900	463	274	540	351	846	657	568	379	4.26	6.89	2.4	2.8	32.7	284700	286927		
1200	660	414	766	520	1192	946	756	510	5.94	9.46	3.5	4.0	43.6	286929	286930		
2000	1101	715	1279	894	1994	1608	1251	865	10	15.2	4.1	4.6	69	286932	286933		
3000	1544	931	1803	1190	2840	2228	1922	1309	14.5	21.38	4.5	5.0	95.5	On request	On request		
4000	2194	1329	2553	1688	3989	3124	2620	1754	20	33	6.0	7.0	150	On request	On request		
5000	2748	1983	3198	2434	5000	4236	2971	2207	25	40	7.5	8.5	168.5	On request	On request		
10000	5105	3233	5938	4067	9274	7403	5939	4068	49	84	10	11	238	On request	On request		

1.) The operating times of the actuator were determined under the following test conditions: (1) Room temperature; (2) Angle of rotation 90°, (3) solenoid valve with Ø 11 mm and flow rate Qn 6000 l/min, (4) internal Ø 11 mm, (5) medium technical air, (6) air pressure 5.5 bar (79.75 Psi), (7) actuator without external load.

Caution: Closing times may change under different operating conditions. Control medium: The control medium must be free of dust and oil. The maximum Particle size must not exceed 30 µm (ISO 8573 Part1, Class 5). To avoid water condensation and/or ice formation (at working temperatures below 0 °C), the medium must have a dew point of -20 °C or at least 10 °C below ambient temperature (ISO 8573 Part 1, Class 3).

6.4. Ordering chart accessories

Position feedback Type 1061

Note:

- Adjustable mounting bracket included
- Further versions see data sheet **Type 1061** ▶

Description	Article no.
Position feedback (electromechanical)	773151
Position feedback (electromechanical) with integrated 3/2 way solenoid valve	773139
Position feedback (electromechanical) with integrated 5/2 way solenoid valve	773140
Position feedback (inductive)	773152
Position feedback (inductive) with integrated 3/2 way solenoid valve	773141
Position feedback (inductive) with integrated 5/2 way solenoid valve	773142
Position feedback (inductive) – ATEX version	773153
Position feedback (inductive) with integrated 3/2 way solenoid valve – ATEX version	773143
Position feedback (inductive) with integrated 5/2 way solenoid valve – ATEX version	773144

Positioner Type 8792**Note:**Further versions see data sheet [Type 8792](#) ▶.

Description	Article no.
Positioner SideControl without analogue feedback	317985
Positioner SideControl with analogue feedback	317986

Positioner mounting kit Type 8792/3**Note:**Further versions see data sheet [Type 8792](#) ▶ or [Type 8793](#) ▶.

Description	Article no.
Universal adapter for shaft	787338
Universal mounting bracket	770294

Solenoid valve Type 6519**Note:**Further versions see data sheet [Type 6519](#) ▶.

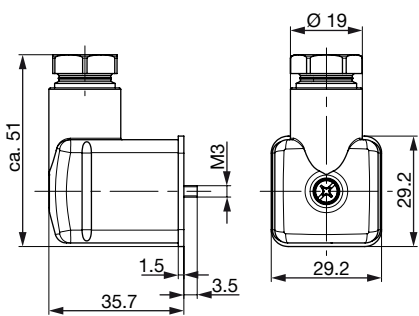

Description	Article no.
3/2 and 5/2 way pneumatic valve 32 mm 24 V DC NAMUR	131421
3/2 and 5/2 way pneumatic valve 32 mm 110 V AC NAMUR	131423
3/2 and 5/2 way pneumatic valve 32 mm 230 V AC NAMUR	131424

Cable plug Type 2518, Form A according to DIN EN 175301 - 803**Note:**Further versions see data sheet [Type 2518](#) ▶.

Cable plug	Dimensions	Version	Voltage	Article no.
		Without circuitry (AC/DC)	0...250 V AC/DC	314802

Conversion sleeves

Description	Article no.
Conversion Sleeve star/square 14/9 mm	665288
Conversion Sleeve star/square 14/11 mm	665289
Conversion Sleeve square/square 17/14 mm	665290
Conversion Sleeve star/square 17/14 mm	773348
Conversion Sleeve star/square 17/11 mm	773343
Conversion Sleeve square/square 22/19 mm	773836
Conversion Sleeve star/square 22/17 mm	684858
Conversion Sleeve star/star 22/14 mm	666684
Conversion Sleeve star/square 22/11 mm	773344
Conversion Sleeve star/square 27/22 mm	774594

Description	Article no.
Conversion Sleeve square/square 27/19 mm	774279 
Conversion Sleeve square/square 27/17 mm	774193 

Bürkert – Close to You

For up-to-date addresses
please visit us at
www.burkert.com

DTS 1000104926 EN Version: M Status: RL (released | freigegeben | validé) printed: 19.11.2019

